

**ACTION PLAN TO ACHIEVE THE
TARGETS OF VISION 2047 FOR FOREST
DEPARTMENT, DNH & DD**

OF TO MDF (14000 ha)

ANNUAL PLAN OF OPERATION OF DADRA & NAGAR HAVELI AND DAMAN & DIU FOREST DIVISIONS FOR THE YEAR (2023-24)

Sr. No.	Name of activity	Physical target for the Year (2023-24)			
		2023-24			
		DNH	Daman	Diu	Total
1.	Plantation in degraded forest (in Ha)	500	-	05	505
2.	Maintenance of previous years plantation (in Ha)	1328	-	-	1328
3.	Bamboo plantation along forest boundaries (in km)	335	05	01	341
4.	Maintenance of previous years Bamboo plantation (in km)	100	-	-	100
5.	Mangrove plantation (in Ha)	-	01	10	11
6.	Creation of new Median Plantation (in km)	4	-	-	4
7.	Maintenance of Median Plantation (in km)	43	33	-	76
8.	Maintenance of Jambu Plantation (in Ha)	25	-	-	25
9.	Maintenance of Sandalwood Plantation (in Ha)	03	-	02	05
10.	Maintenance of Roadside plantations (in km)	29	10	04	43
11.	Creation of Rubble Wall (in km)	05	-	-	05
12.	Sowing of creeper seeds (in Km)	60	-	-	60
13.	Maintenance of Drumstick plantation (in Ha)	30	-	-	30
14.	Seed ball broadcasting (in Nos.)	01 Lakh	-	-	01 Lakh
15.	Staggered Contour Trenching work (in Ha)	100	-	-	100
16.	Green kit distribution (in Nos.)	2000	100	100	2200
17.	Fencing of Forest boundary & Plantation with Chain Link (in km)	150 (approx)	-	-	150 (approx)
18.	Water Holes (in Nos.)	05	-	-	05
19.	Artificial Bird Nest (in Nos.)	05	02	01	08
20.	Ficus Plantation (in Nos.)	600	100	200	900

ANNUAL PLAN OF OPERATION OF DADRA & NAGAR HAVELI AND DAMAN & DIU FOREST DIVISIONS FOR THE YEAR (2023-24)

Sr. No.	Name of activity	Physical target for the Year (2023-24)			
		2023-24			
		DNH	Daman	Diu	Total
21.	Raising of Seedlings				
	(a) Raising of all types of Seedlings (excluding Bamboos) in Nursery (in Nos.)	13.43 Lakh	1.5 Lakh	1.25 Lakh	16.18 Lakh
	(b) Bamboo seedlings (in Nos.)	21.25 Lakh			
22.	Development of Nursery (Temp) -5Nos.	03 Nos.	01 No.	01 No.	05 Nos.
23.	Education and awareness programmes towards conservation of Forests and Wildlife for students/ General public NGOs/other departmental officers and staffs on important Environment /Wildlife /Forestry days .	Minimum five programme in each Division and the awareness programme should continue during the whole year. Important days include 22 nd April – Earth Day ; 22 nd May- Biodiversity day; 5 th June – World Environment Day; July- Van mahotsav; 26 th July-Mangrove Day; 16 Sept – World Ozone Day; 17 th Sept- International coastal clean up day; October- Wildlife Week; 2 Feb – World Wetland; 21 March-World forests day etc.			

ACTION PLAN OF DADRA & NAGAR HAVELI AND DAMAN & DIU
FOREST DEPARTMENT – VISION 2047

Sr. No.	Name of Activity	2023-24	2024-25	2025-26	2026-27	2027-28	Cumulative Total
1.	New Seedlings to be planted in degraded/ Open Forest (in Lacs.)	4.04 (505 ha)	4.04 (505 ha)	4.04 (505 ha)	8 (1000 ha)	8 (1000 ha)	28.12 (3515 ha)
2.	Mangroves seedlings to be planted (in Lacs)	1.1 (11 ha)	1.1 (11 ha)	1.1 (11 ha)	1.1 (11 ha)	1.1 (11 ha)	5.5 (55 ha)
3.	Bamboo seedlings to be planted along the boundary of forest (in Lacs)	20.10 (335 km)	20.10 (335 km)	20.22 (337 km)	-	-	60.42 (1007 km)
4.	Seedlings to be raised in Nurseries						
	a) Mixed Species seedlings (in Lacs)	16.18	19.67	20.21	17.87	18.045	91.97
	a) Bamboo seedlings (in Lacs)	21.25	25.02	30.06	12	8.06	96.39
	a) Mangrove seedlings (in Lacs)	1.15	1.15	1.15	1.15	1.15	5.75
5.	Seedlings to be planted in median plantation (in Nos.) * As per availability of land	24000	24000	24000	-	-	72000
6.	Seed ball broadcasting (in Lacs)	01	01	01	01	01	05
7.	Staggered Contour Trenching work (in Nos.)	7800	7800	7800	7800	7800	39000
	Green kit distribution to beneficiary						

ACTION PLAN OF DADRA & NAGAR HAVELI AND DAMAN & DIU
FOREST DEPARTMENT – VISION 2047

Sr. No.	Name of Activity	2023-28	2028-33	2033-38	2038-43	2043-47	Cumulative Total
1.	New Seedlings to be planted in degraded/ Open Forest (in Lacs.)	28.12 (3515 ha)	23.05 (3294 ha)	16.81 (2402 ha)	16.81 (2402 ha)	16.71 (2387 ha)	101.50 (14000 ha)
2.	Mangroves seedlings to be planted (in Lacs)	5.5	5	5	5	5	25.5
3.	Bamboo seedlings to be planted along the boundary of forest (in Lacs)	60.42	-	-	-	-	60.42
4.	Seedlings to be raised in Nurseries						
	a) Mixed Species seedlings (in Lacs)	91.97	86.49	75.22	74	74	401.68
	a) Bamboo seedlings (in Lacs)	96.39	05	05	05	05	116.39
	a) Mangrove seedlings (in Lacs)	5.75	5	5	5	5	25.75
5.	Seedlings to be planted in median plantation (in Nos.) * As per availability of land	72000	-	-	-	-	72000
6.	Seed ball broadcasting (in Lacs)	05	05	05	05	05	25
7.	Staggered Contour Trenching work (in Nos.)	39000	39000	39000	39000	39000	195000
8.	Green kit distribution to beneficiary (in Nos.)	11000	2000	2000	2000	2000	5 19000

JAN BHAGIDARI

- The Forest Departments, DNH and DD distribute 40 thousands seedlings every year to 2200 beneficiaries of tribal villagers of DNH & DD.
- The Forest Departments, DNH and DD takes up plantations(10000 nos. of seedlings) every year during the celebration of various programs related to Forests and Environment.
- The Forest Departments, DNH and DD distribute 5 lakh plants every year to the general public.
- The Forest Departments, DNH and DD has planted 1400 nos. of Ficus plants in various Panchayats of DNH and DD. The special plantation drive will be taken up every year as per the availability of the Revenue or Panchayat areas.
- The Forest Departments, DNH and DD carries out plantation for median and roadside plantations in various districts of DNH and DD.

ENVIRONMENTAL TOURISM

- The Forest Departments, DNH and DD has planned to develop an Eco Tourism Site at Kauncha to increase the Environmental Tourism in the Union Territory. The project shall be completed by 2025.
- The Components of ECO Tourism Site of Kauncha includes the following
 1. Zip Line.
 2. Tree House.
 3. Canopy walk way
 4. Viewing Deck
 5. Nature Trail
 6. Boating



ECO-TOURISM SITE

at Kaucha, U.T. of DNHDD



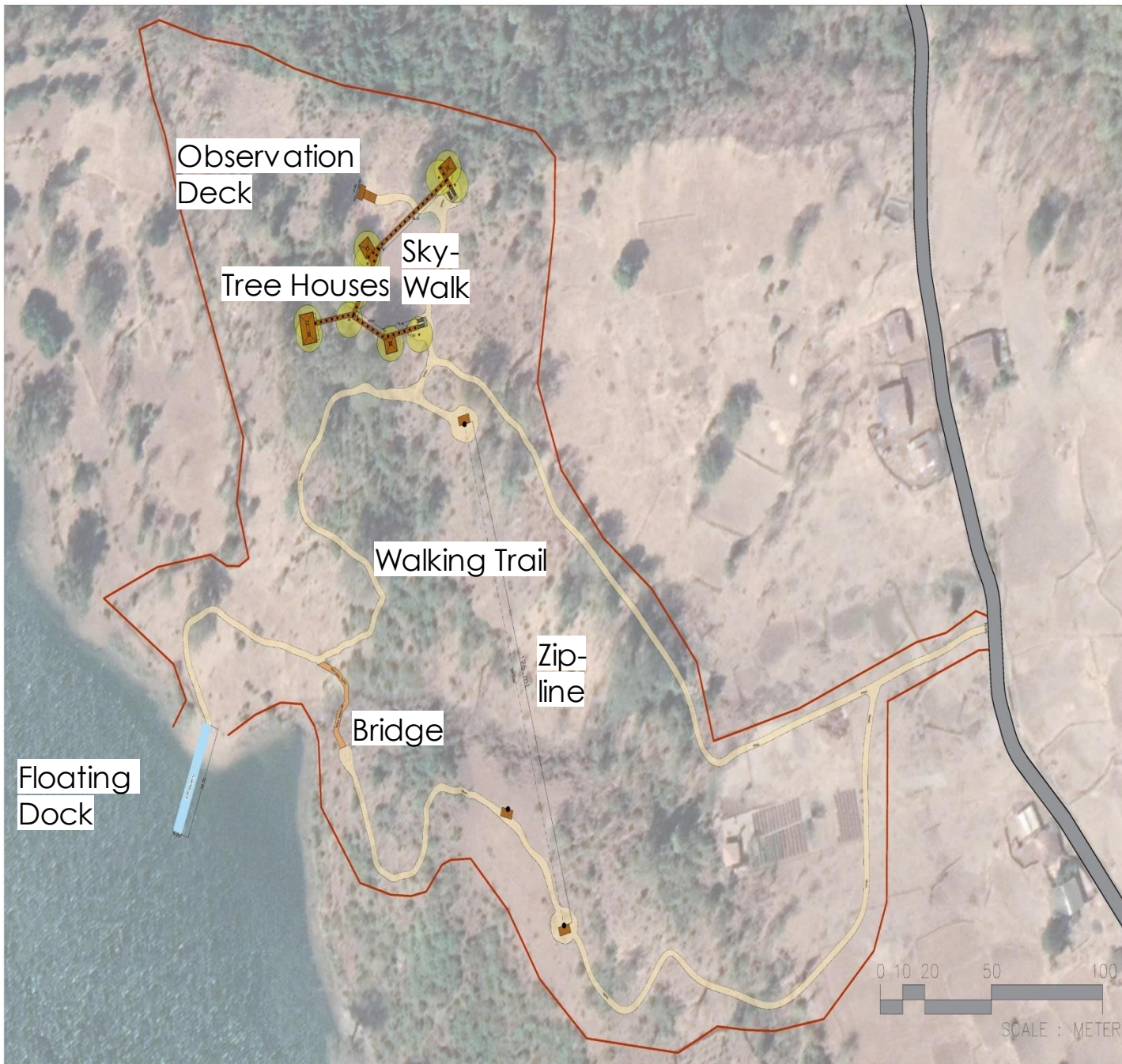

Site Layout

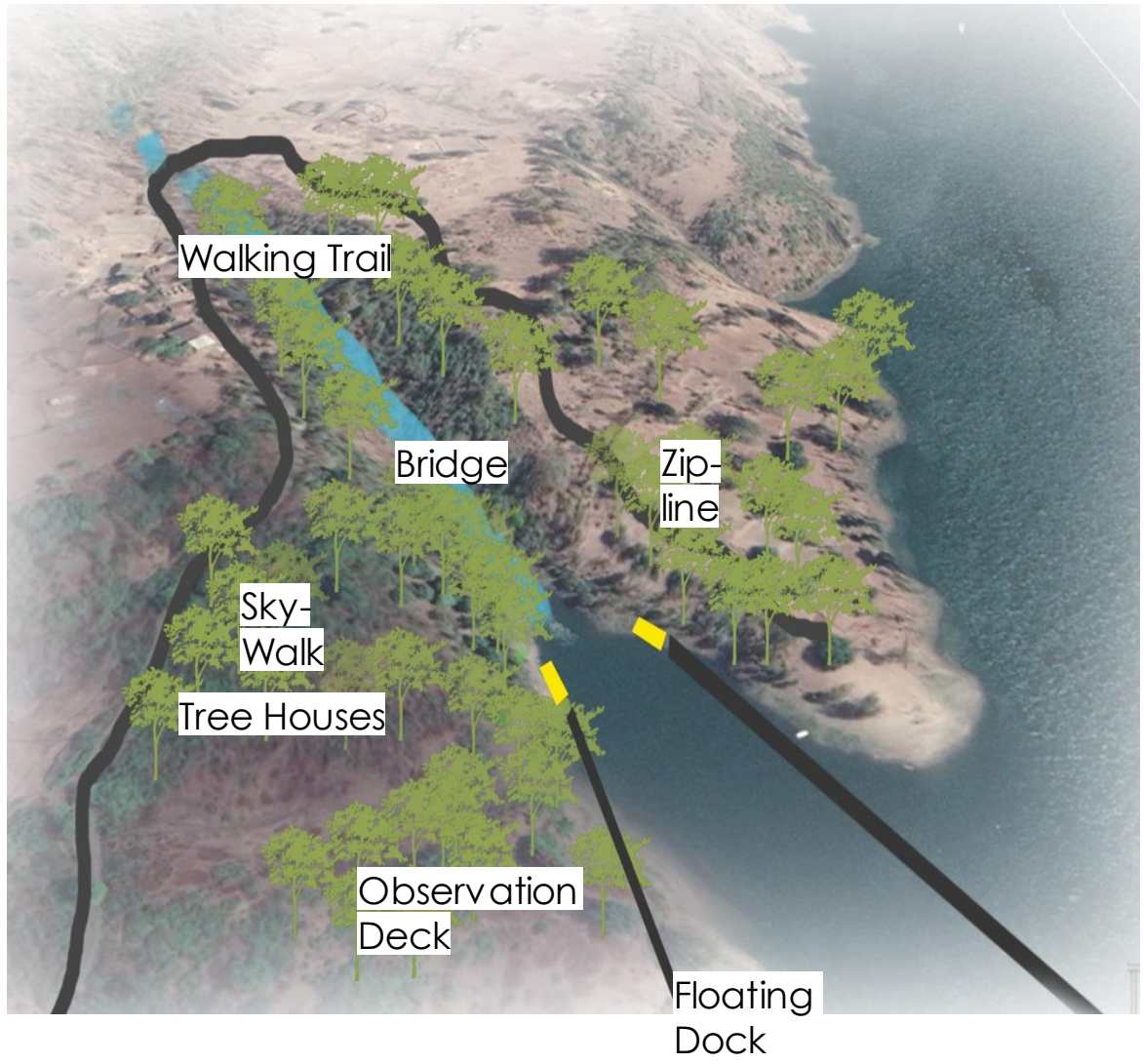

Walking Trail

Bridge

Zip-line

Sky-Walk

Tree Houses

Observation Deck

Floating Dock



Natural Trails

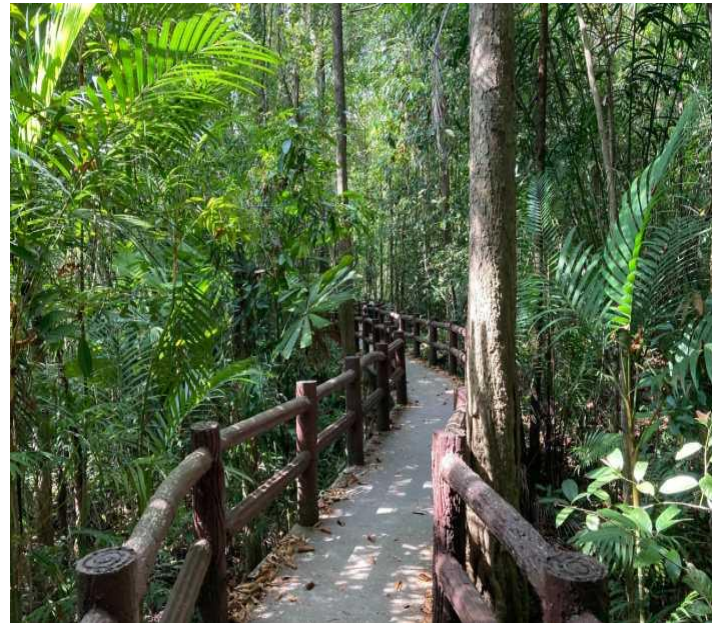

Jungle Walking Trail

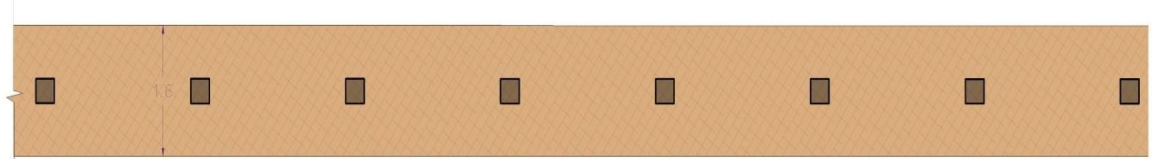

SKY WALK PLAN

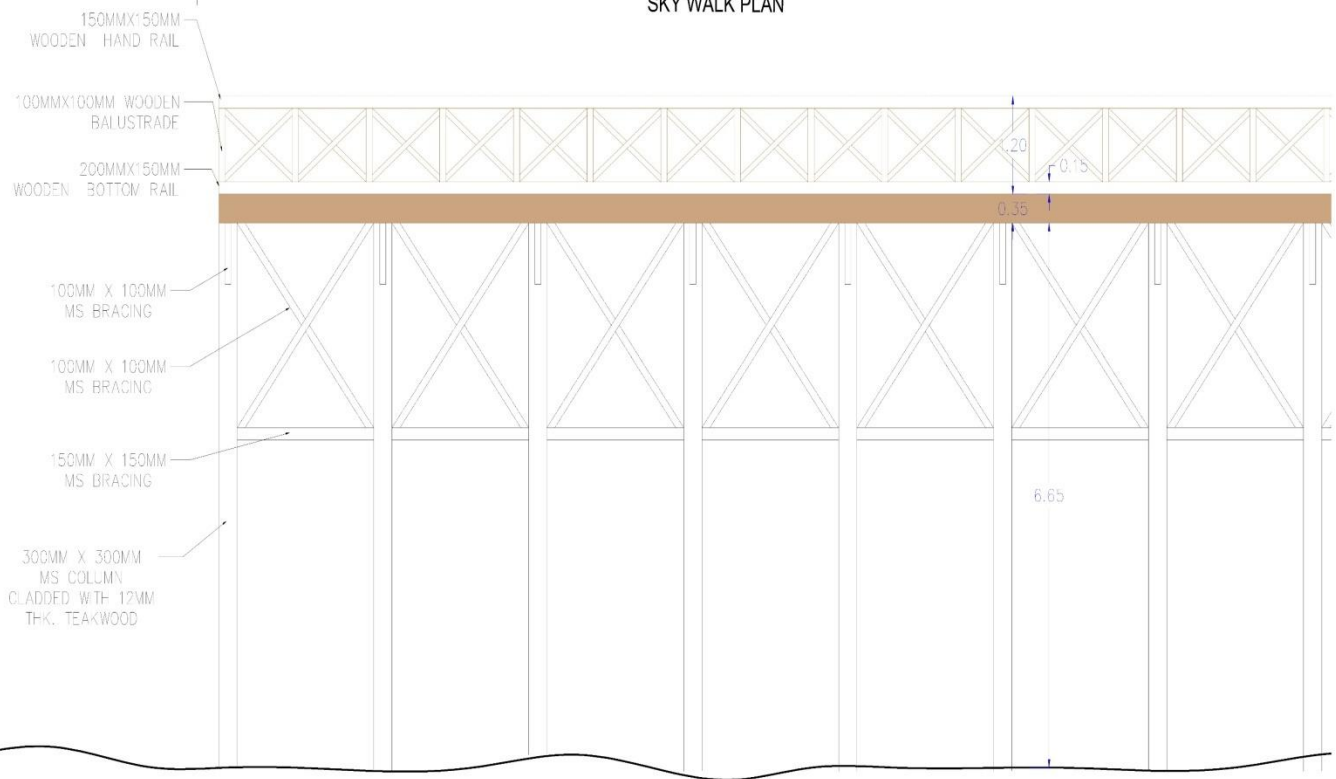

SKY WALK ELEVATION

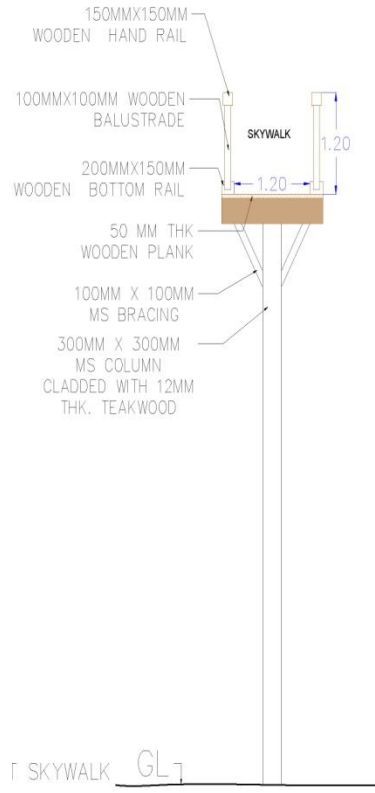

SKYWALK GL



Jungle Sky-Walk

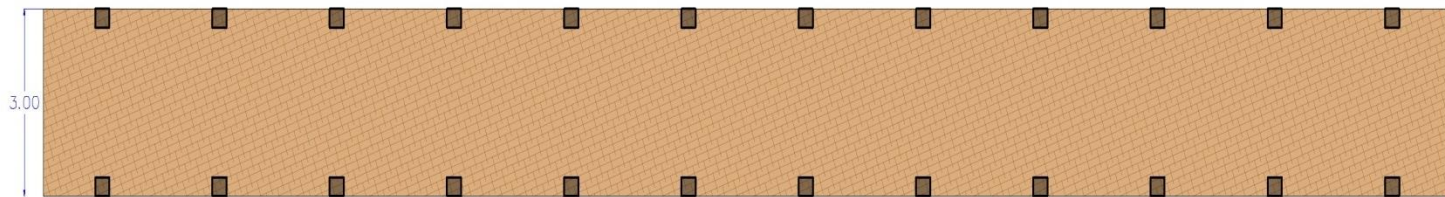

BRIDGE - PLAN

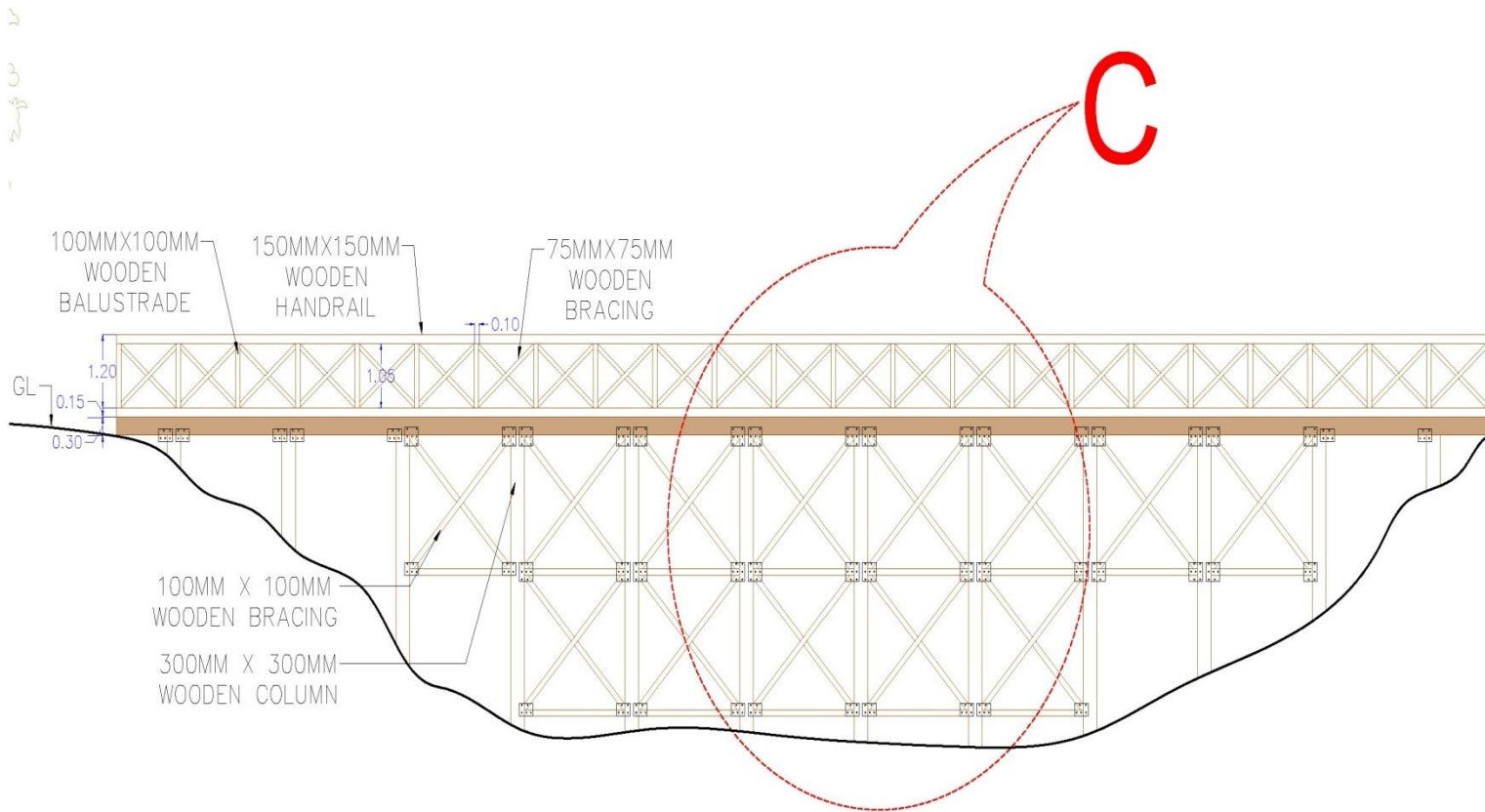

BRIDGE ELEVATION

من قوس



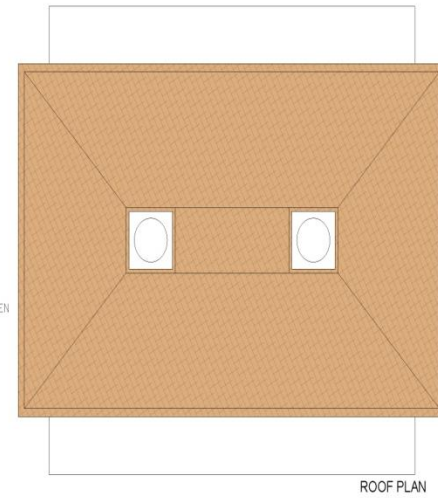
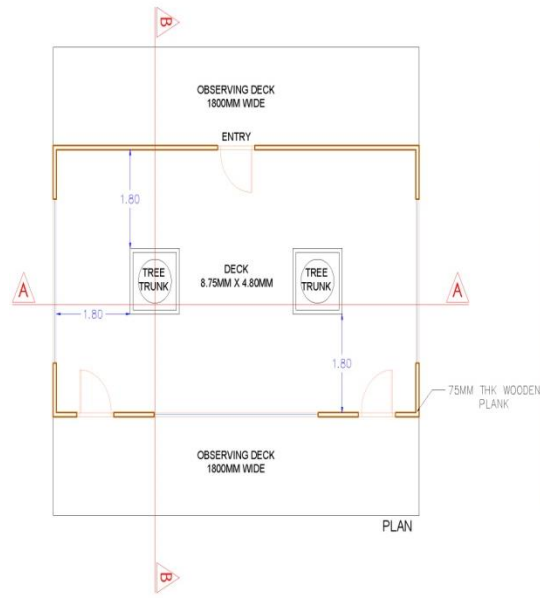
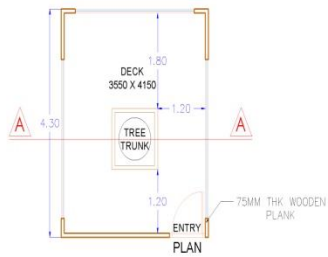
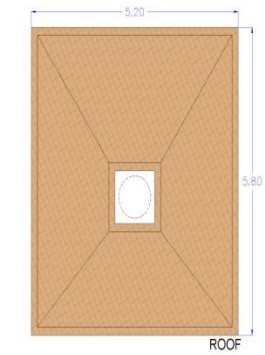
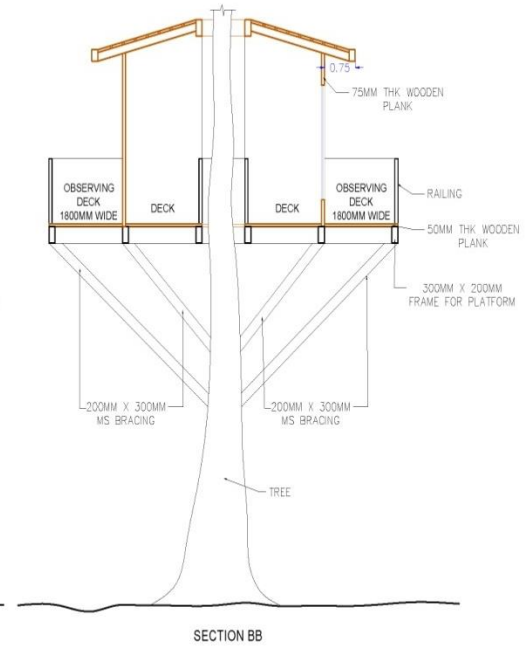
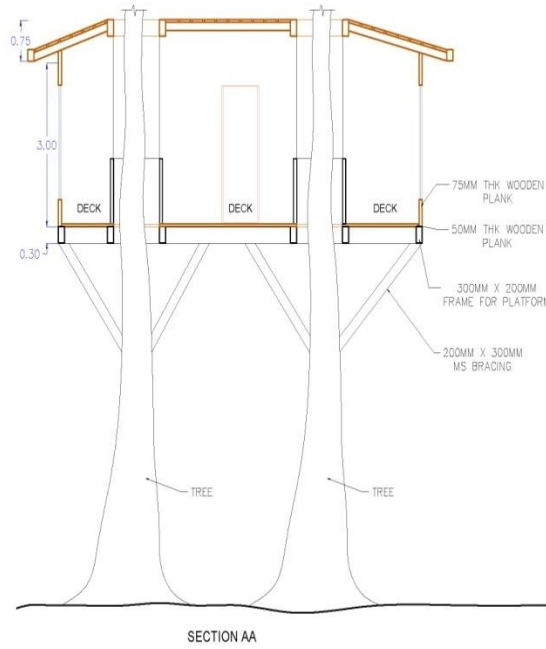
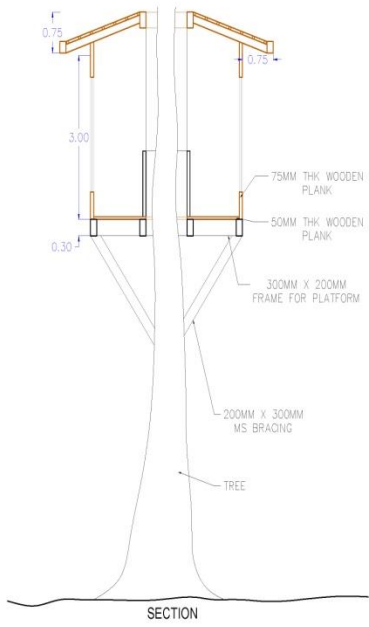



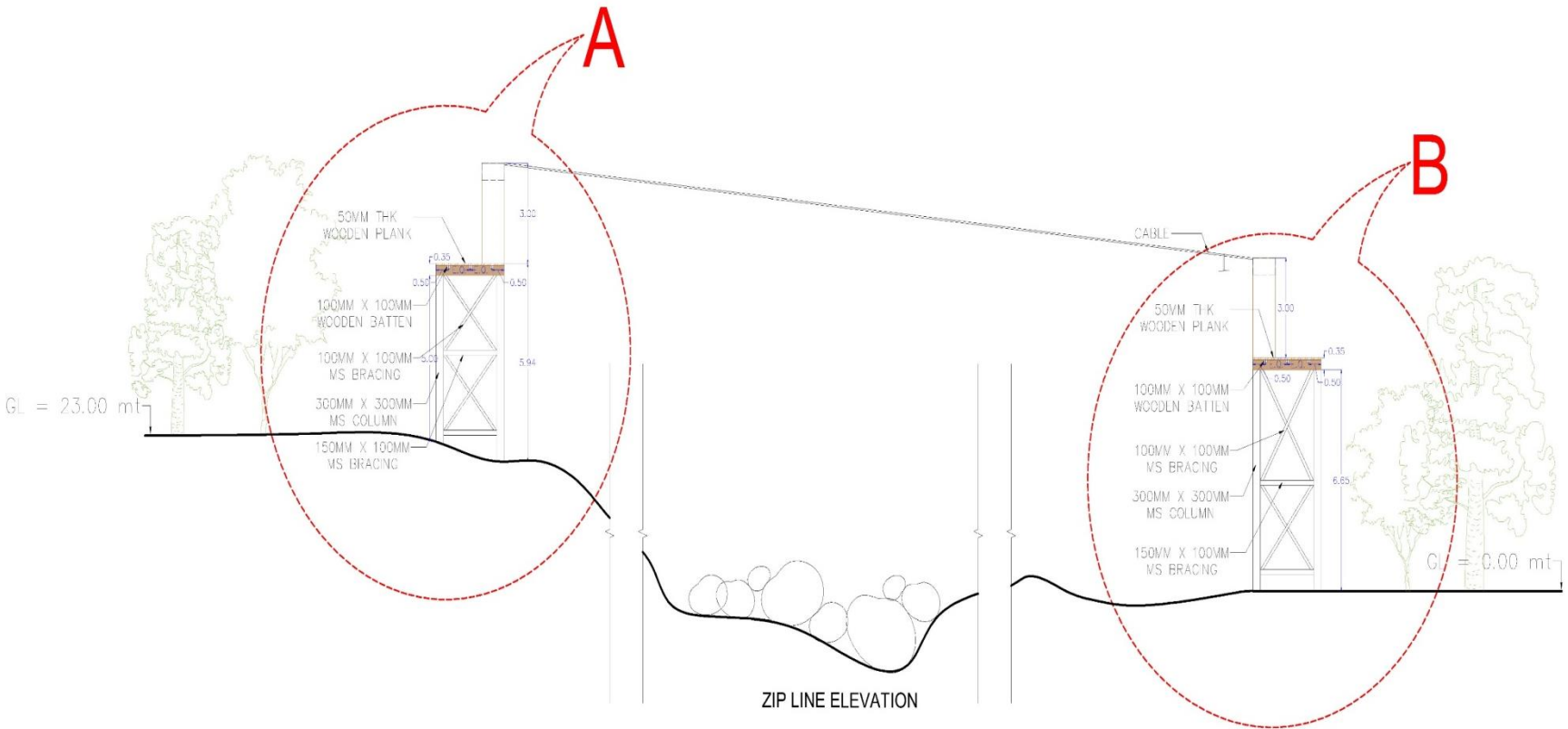
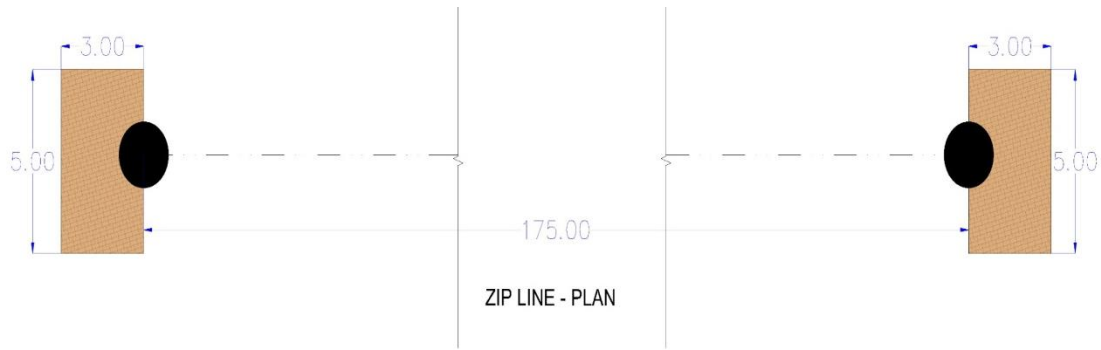

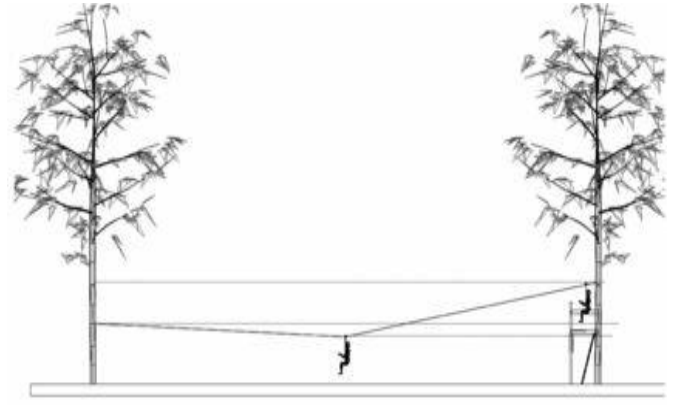
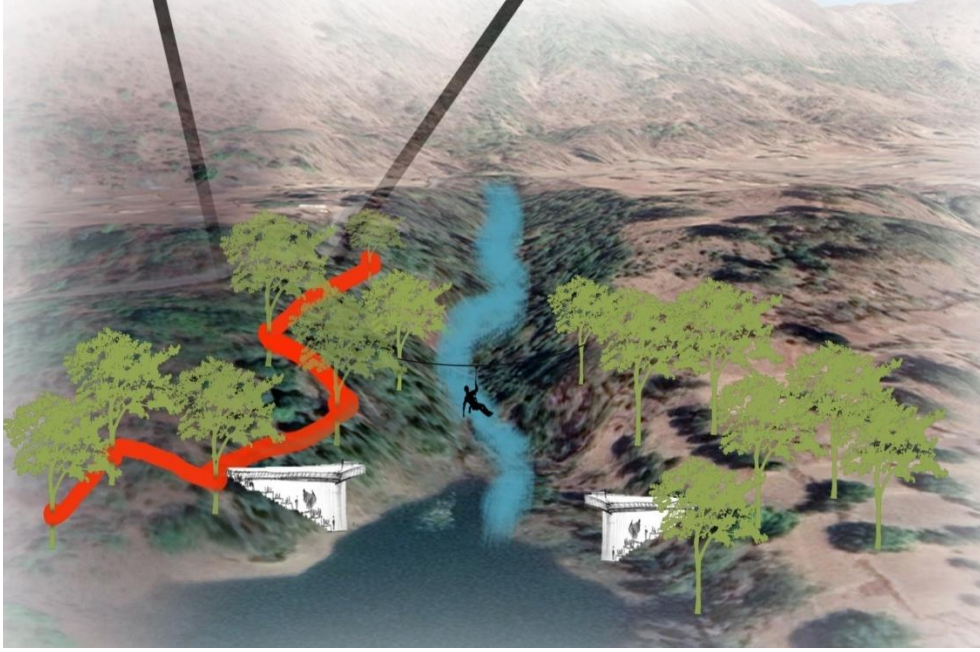

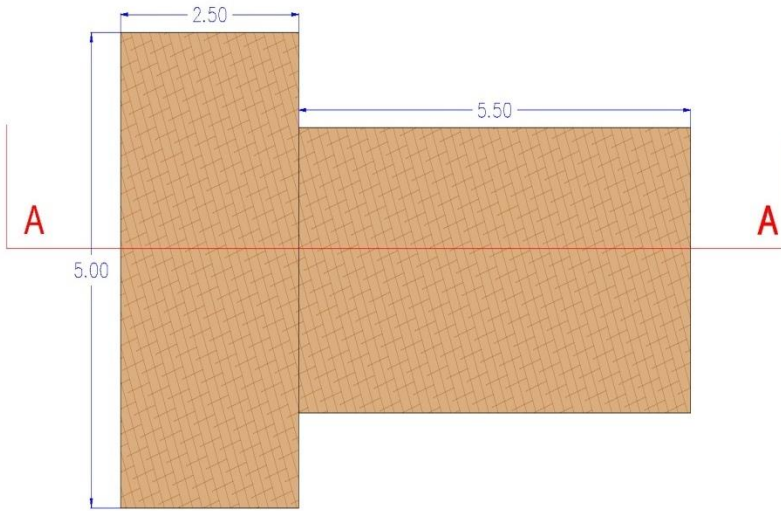

VIEWING DECK PLAN

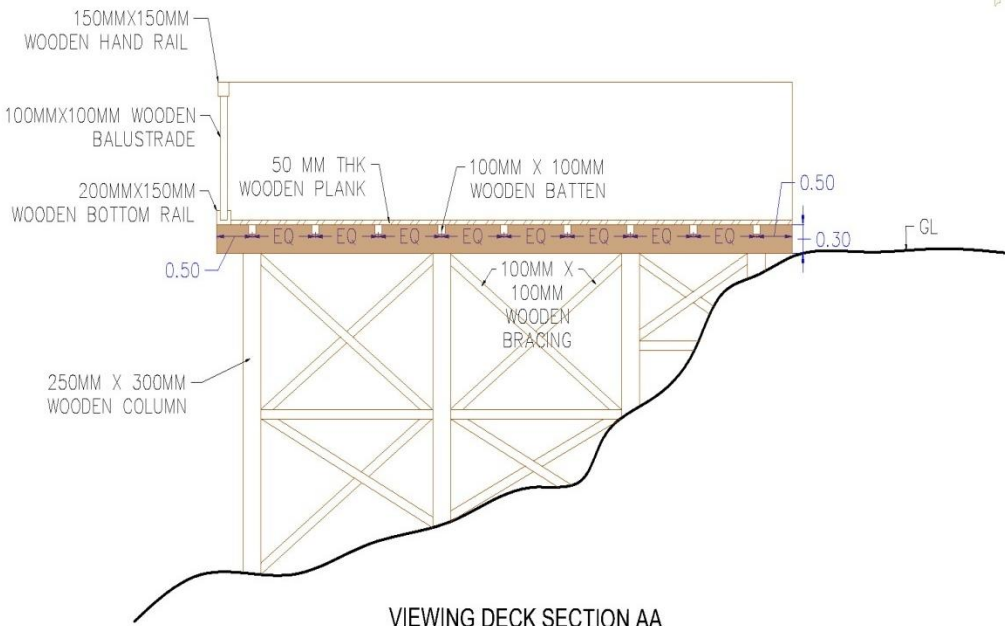
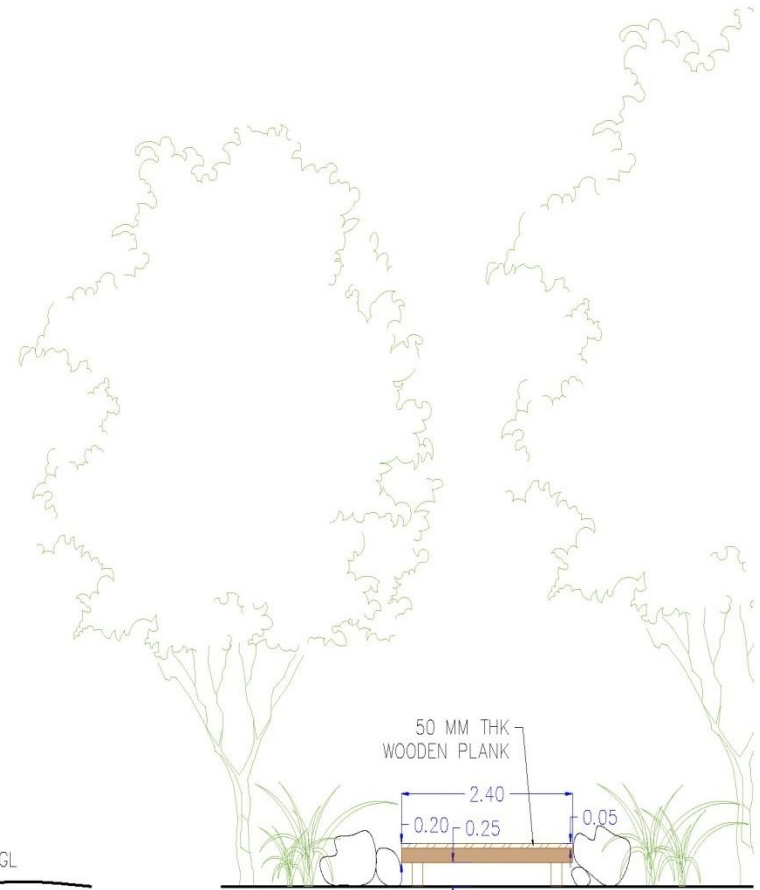

VIEWING DECK SECTION AA

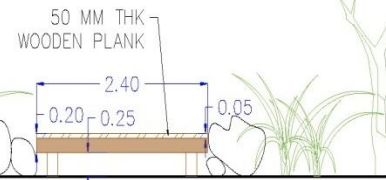

TRAIL

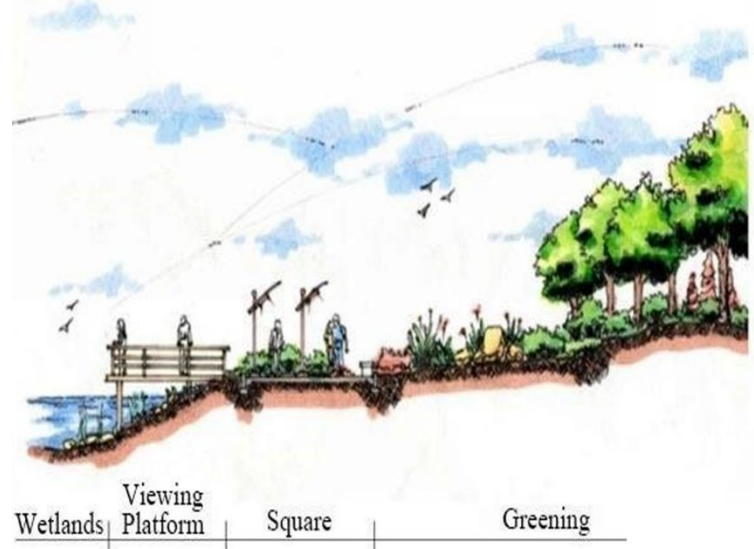



Floating Dock

AWARENESS PROGRAMS

- The Forest Departments, DNH and DD celebrates various awareness programs related to Forests and Environment to raise awareness conserve & protect our Forests and Environment.
- The Important days include 22nd April – Earth Day ; 22nd May-Biodiversity day; 5th June – World Environment Day; July- Van mahotsav; 26thJuly-Mangrove Day; 16 Sept – World Ozone Day;17th Sept-International coastal clean up day; October- Wildlife Week;2 Feb – World Wetland; 21 March-World forests day.
- The awareness programs are carried out every year during the important days of celebrations.

Thank You !!